

star

hydraulics ltd

SERVO TECHNOLOGY
AND RESEARCH

Model 557 Servovalve



- Nominal flows rates 1 to 75 l/min @ 70 bar
- Sapphire Technology
- Medium & High-Response characteristics
- External pilot supply & return

Star Hydraulics Ltd.
8A Beta Close
Tewkesbury Industrial Centre
Tewkesbury
Gloucestershire GL20 8SR
England U.K.

Tel.: 01684 296176
Fax.: 01684 850714

Email: sales@star-hydraulics.co.uk
Web: <http://www.star-hydraulics.co.uk>

Nominal flow ratings	4, 10, 20, 40, 60, 75 l/min at 70 bar p For other flow ratings contact factory
Hysteresis	< 3% without dither
Threshold	< 0.5% without dither
Null bias	< 2%
Null shift	
with 40°C temp change	< 2%
with 70 bar supply pressure change	< 2%
with return pressure 0 to 35 bar	< 2%
Pressure gain	< 1% rated input signal for 60% of supply pressure
Seal materials available	FPM, NBR, EPDM
Operating temperature range	-30 °C to 130 °C
Proof pressure	
at pressure port	150% max supply pressure
at return port	100% max supply pressure
Burst pressure	
return port open	250% max supply pressure
External leakage	zero
Degree of protection	IP 65 (BS EN 60529 : 1992)
Weight	1 kg
Mounting position	Any, fixed or movable

Supply filtration	
minimum	10 75 (10 micron abs)
recommended	5 = 200 (5 micron abs)
Fluid cleanliness level	
minimum	ISO 4406 - 16/13 NAS 1638 - class 7
recommended	ISO 4406 - 13/10 NAS 1638 - class 4
Supply pressure	
min. to effect spool movement	3.5 bar
minimum recommended	15 bar
maximum continuous	210 bar (FPM & EPDM) 315 bar (NBR)
Viscosity	VG 10 to 100 ISO 3448
Fluid type	Petroleum based mineral oils For operation with other media contact factory

Calculating output flow

The output flow for a given pressure drop can be calculated using the following:

$$q = q_N \sqrt{\frac{\rho_N}{\rho_V}}$$

Where:

q = Output flow [l/min]

q_N = Rated flow [l/min]

ρ_N = Valve pressure drop [bar]

ρ_V = Rated valve pressure drop [bar]

Output flow versus load pressure difference

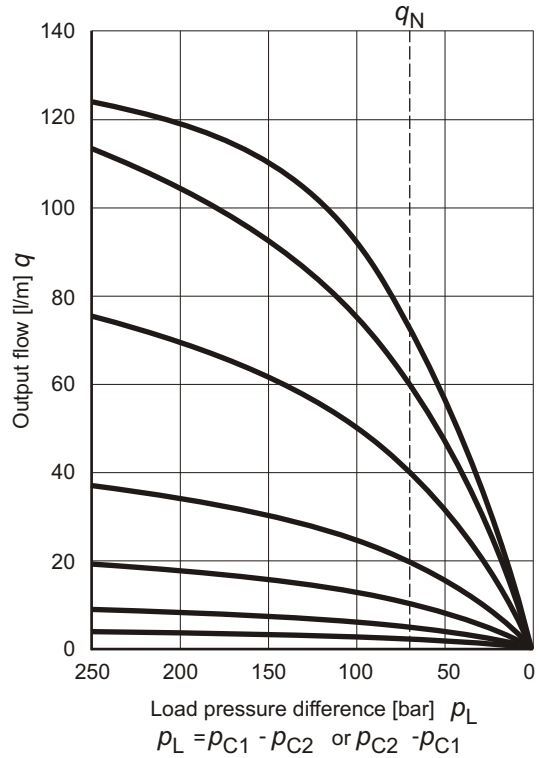

Internal leakage

This comprises of both pilot stage flow (tare leakage) and the second stage null leakage, typical values for this size of valve would be:

Rated flow	Internal leakage at 140 bar
4 l/min	< 1.0 l/min
10 l/min	< 1.2 l/min
20 l/min	< 1.6 l/min
40 l/min	< 1.6 l/min
60 l/min	< 1.6 l/min
75 l/min	< 1.6 l/min

Output flow versus input signal at constant valve pressure drop

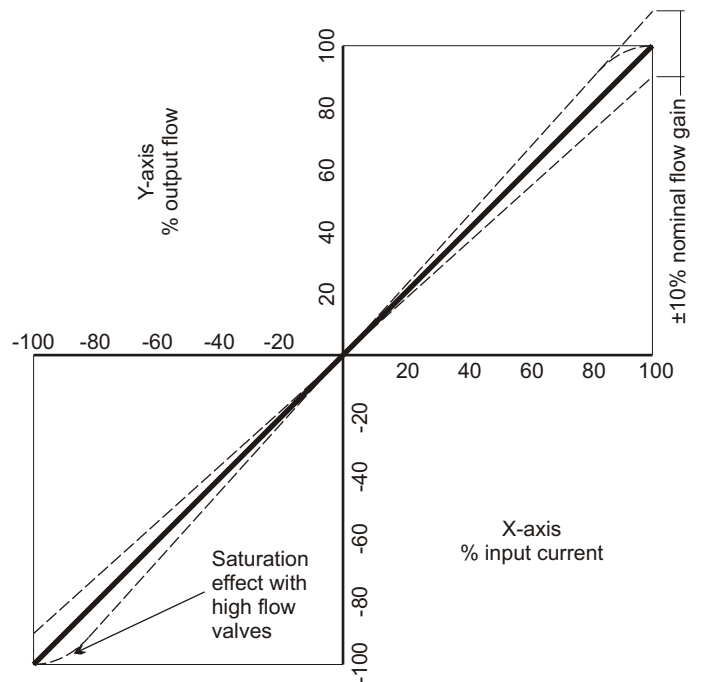

The flow tolerance for standard servovalves is $\pm 10\%$ of the nominal rated flow at $\pm 100\%$ input signal.

The rated flow is quoted at 70 bar p and 100% rated input signal.

Coil schematics

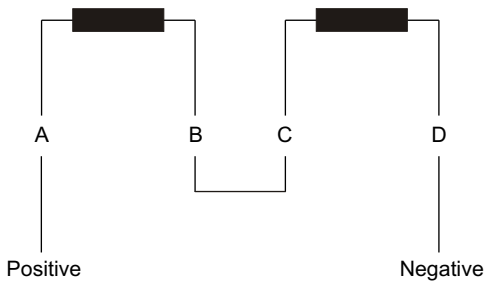

Series connection

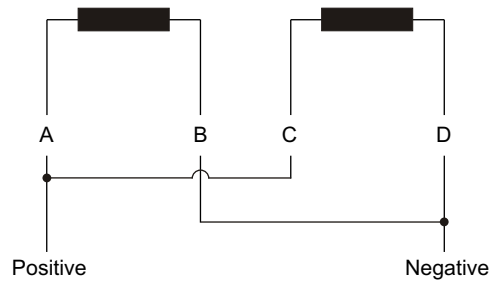

Parallel connection

Output flow polarity

Flow in the direction of P→C2, C1→R will occur with the pilot stage coils configured as above.

Coil options

Coil specification		Series connection		Parallel connection	
Rated signal [mA]	Resistance per coil [Ω]	Input current [mA]	Effective resistance [Ω]	Input current [mA]	Effective resistance [Ω]
10	1000	5	2000	10	500
15	200	7.5	400	15	100
20	1200	10	2400	20	600
30	300	15	600	30	150
30	800	15	1600	30	400
40	80	20	160	40	40
60	40	30	80	60	20
80	22	40	44	80	11
100	27	50	54	100	13.5
200	22	100	44	200	11

Electrical connection

Standard connector is MS3102E-14S-2P (MIL-C-5015). Please contact factory for more options.

Transient Response (MR)

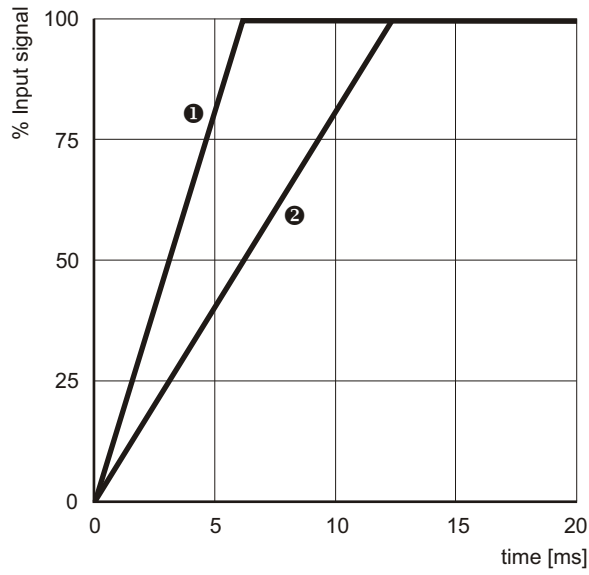

[1] Rated flow = 4 l/min
 [2] Rated flow = 60 l/min
 Supply pressure = 210 bar

Frequency Response (MR)

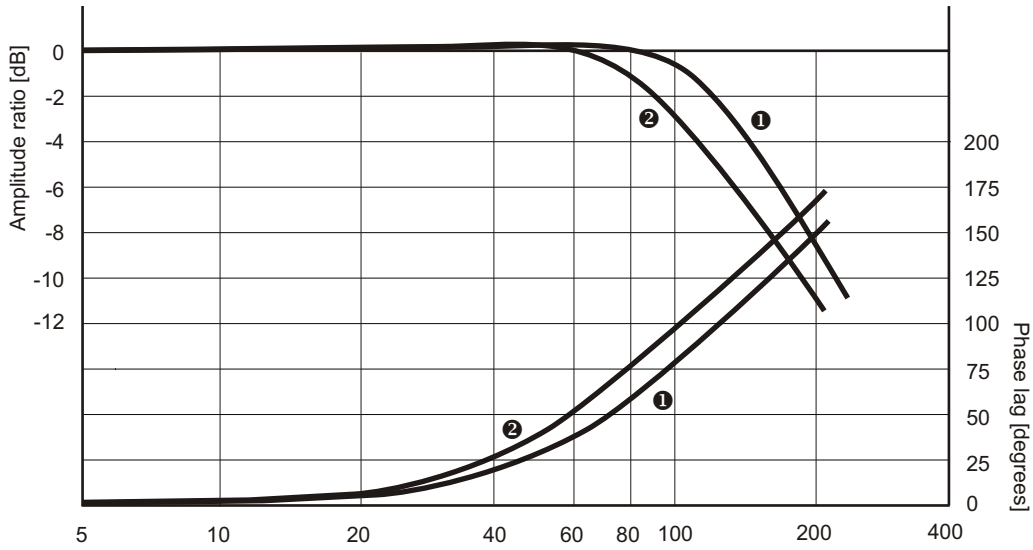

Input signal = 25%
 [1] Rated flow = 4 l/min
 [2] Rated flow = 60 l/min
 Supply pressure = 210 bar

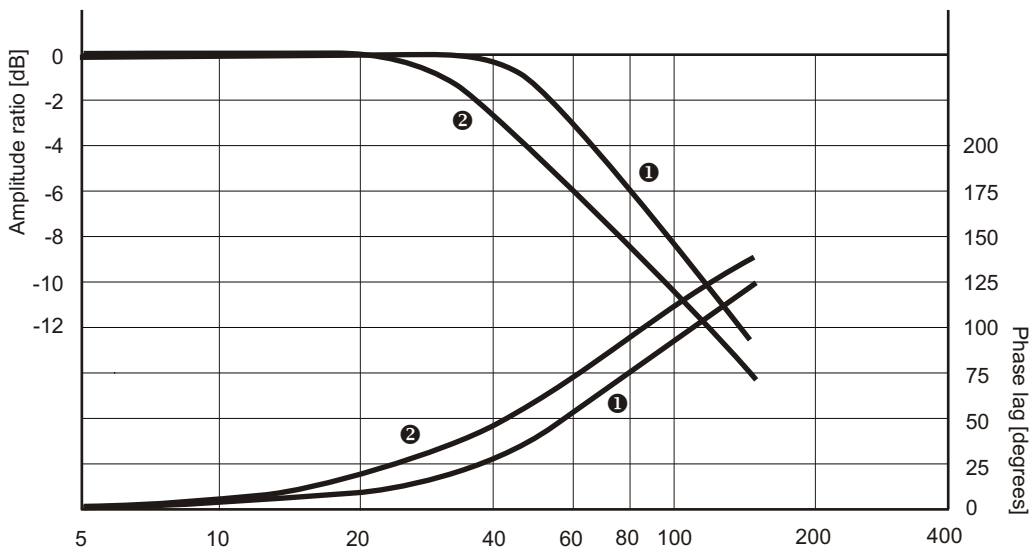

Input signal = 100%
 [1] Rated flow = 4 l/min
 [2] Rated flow = 60 l/min
 Supply pressure = 210 bar

Transient Response (HR)

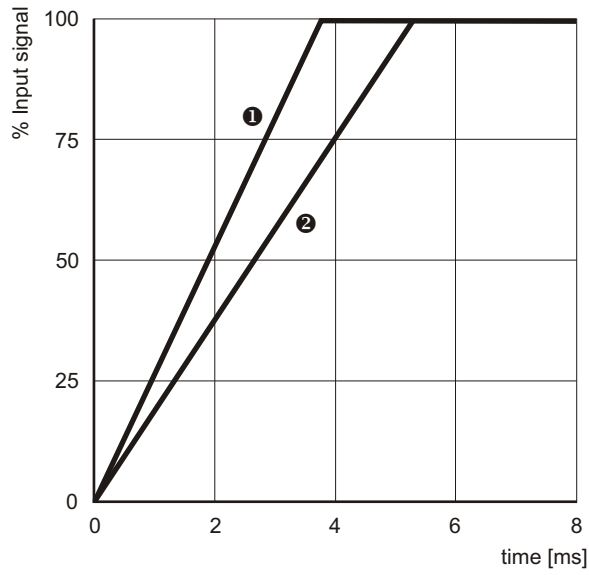

[1] Rated flow = 4 l/min
 [2] Rated flow = 40 l/min
 Supply pressure = 210 bar

Frequency Response (HR)

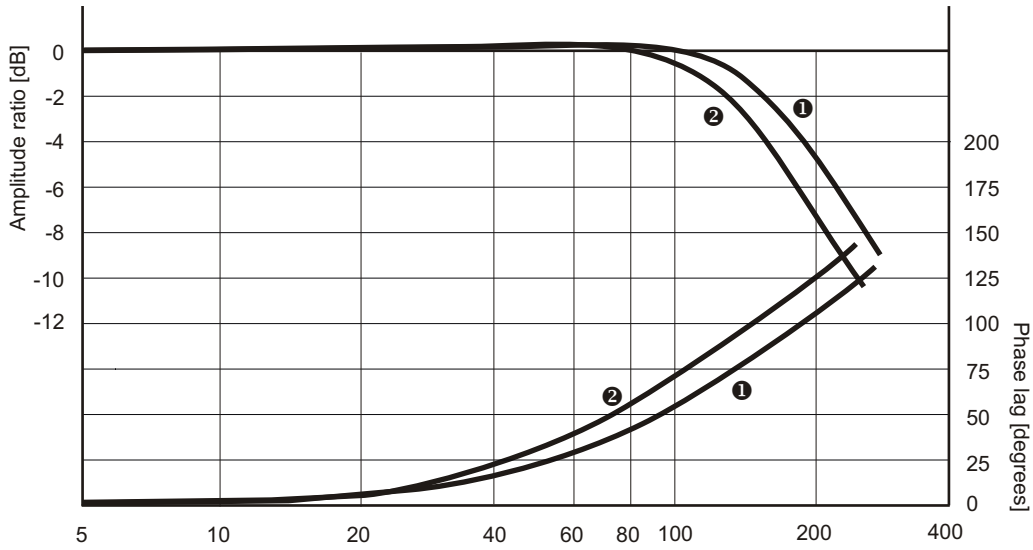

Input signal = 25%
 [1] Rated flow = 4 l/min
 [2] Rated flow = 40 l/min
 Supply pressure = 210 bar

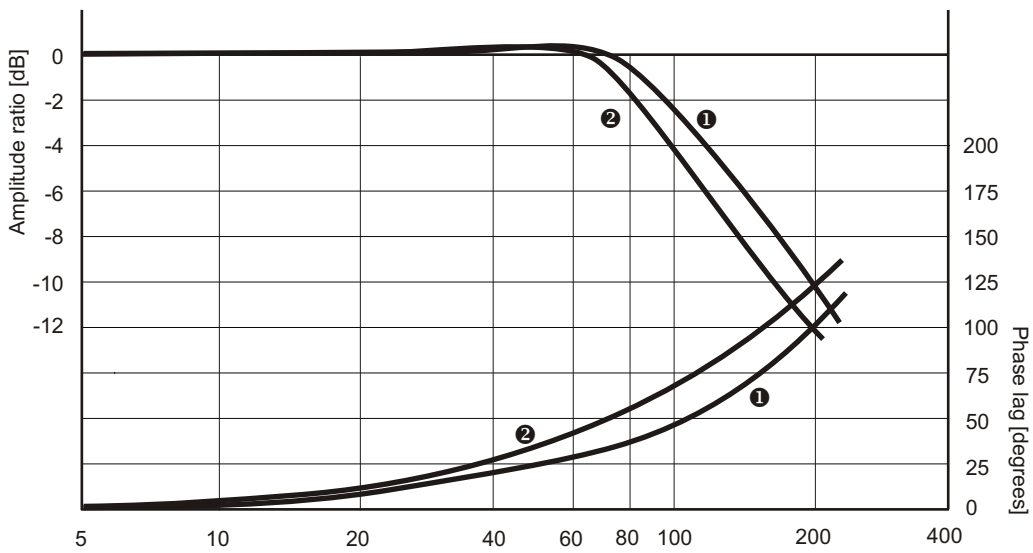

Input signal = 100%
 [1] Rated flow = 4 l/min
 [2] Rated flow = 40 l/min
 Supply pressure = 210 bar

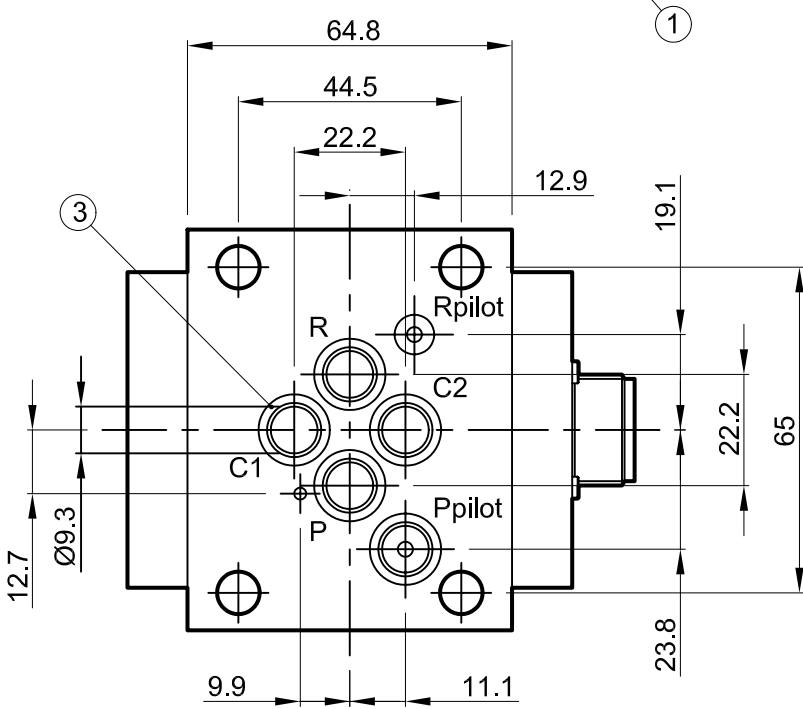
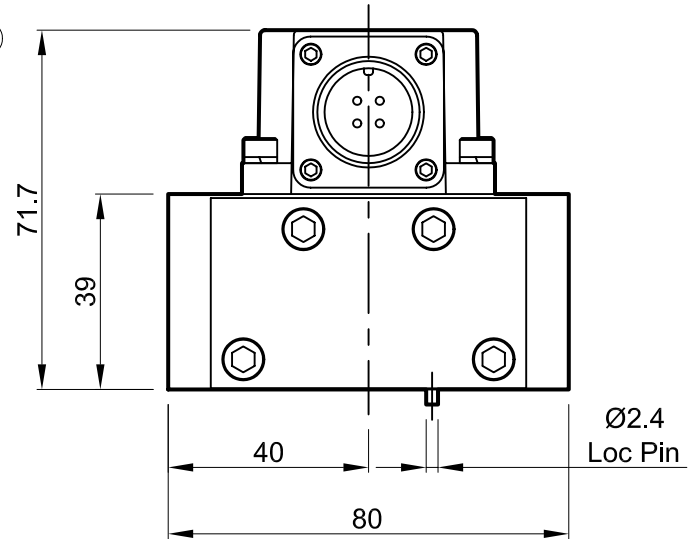
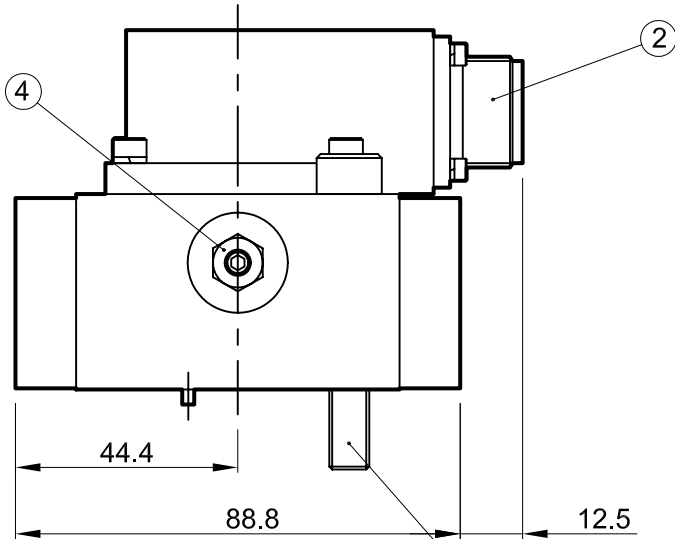

1. Suggested mounting bolts M8 x 60 long high tensile steel socket head cap screws.
2. 4-way electrical connector mates with MS3106-14S-2S or equivalent. Is available at $\pm 90^\circ$ and 180° to position shown (advise desired position at time of order).
3. Base O-Rings: 10.82 I/D x 1.78 section (5 pcs). 4.47 I/D x 1.78 section (1 pc).
4. Null adjust requires 10 A/F ring spanner and 2.5 hexagon key. Flow out of C2 will increase with clockwise rotation of key.

Installation Details Model 557

Dimensions in millimeters 3rd angle projection	Filename
---	----------

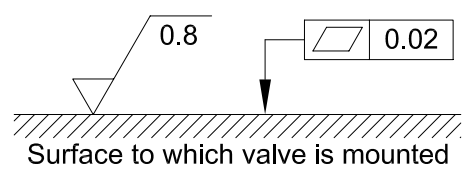

C/BORE FOR
LOC PIN
Ø3 X 5

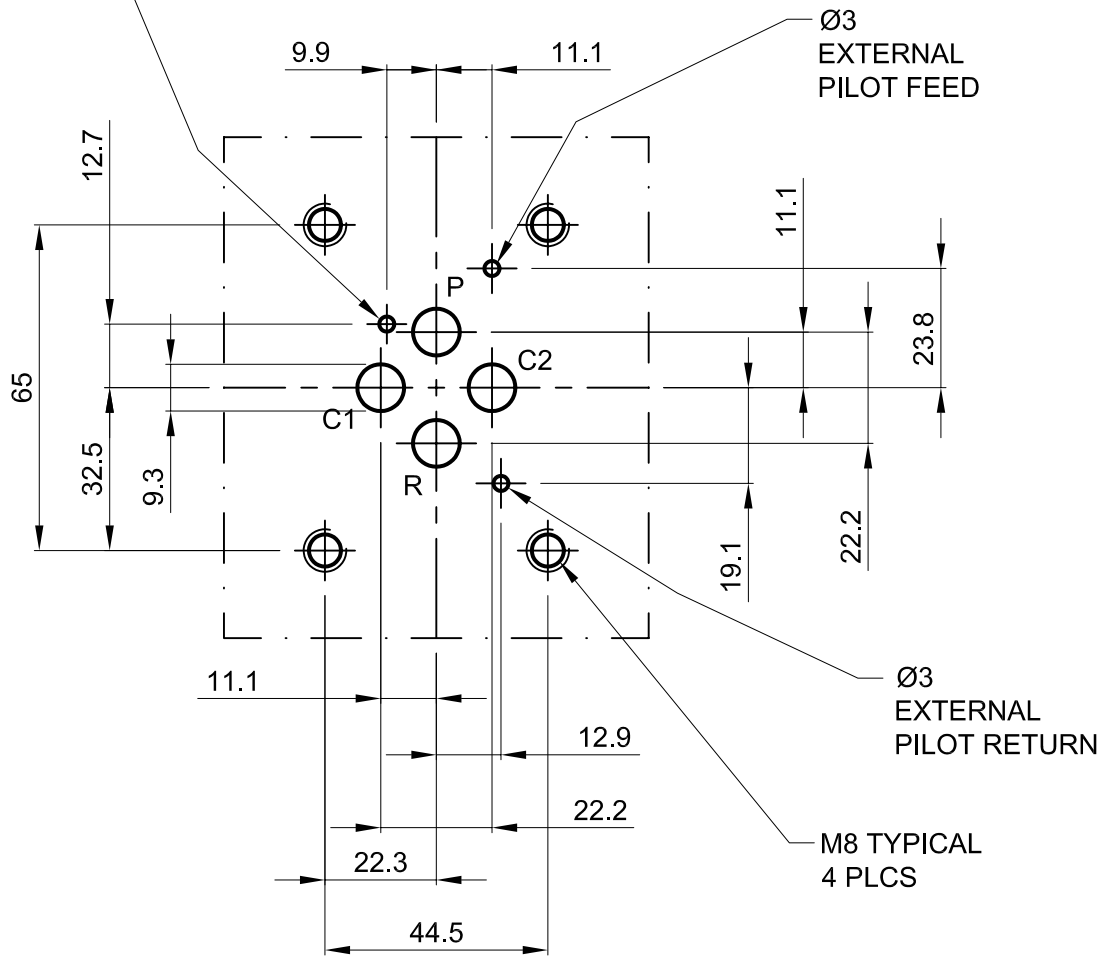

Manifold Dimensions Model 557

Dimensions in millimeters
3rd angle projection

Filename

